

IPC Accessories Installation Guide

2022-01-17

Box camera mount

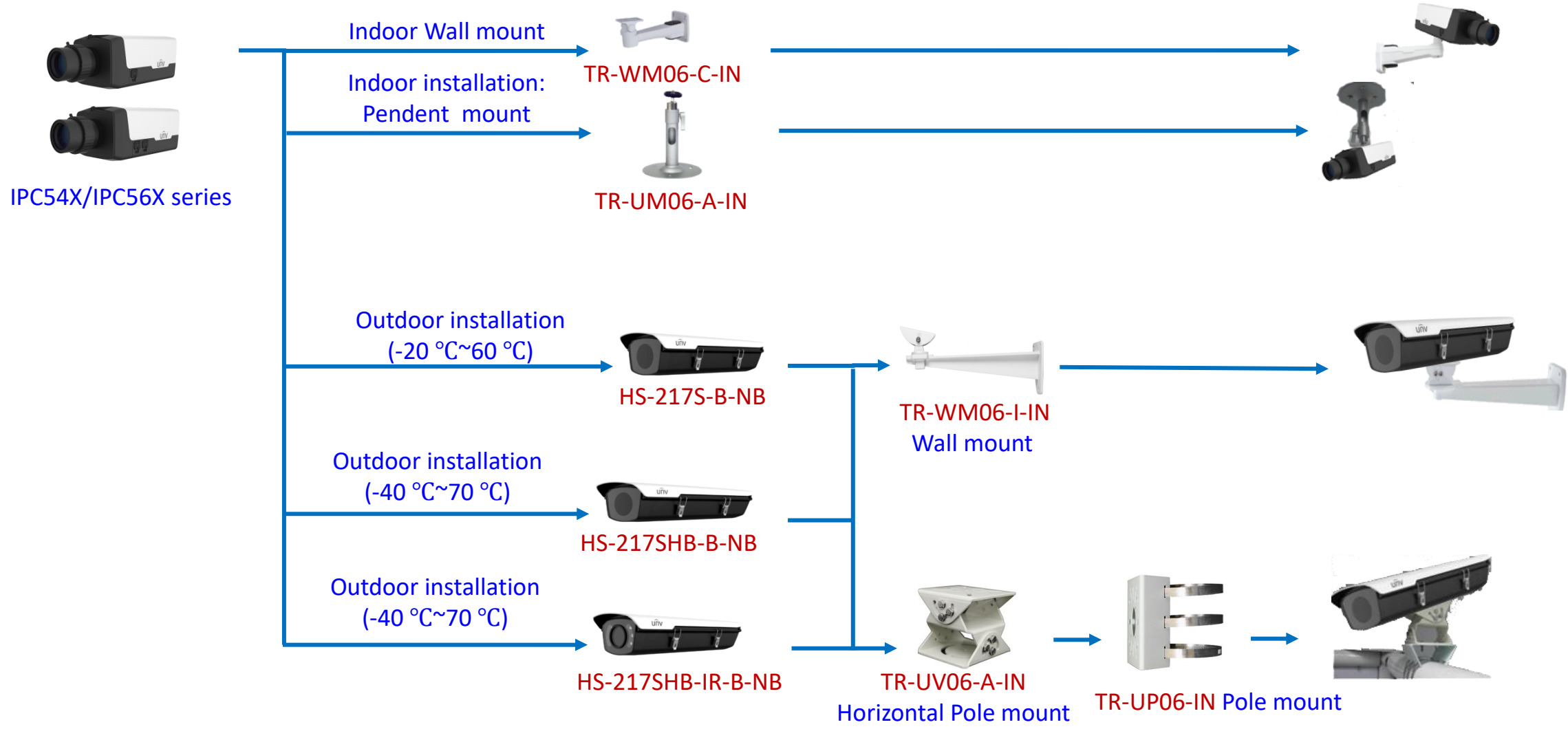

Dome camera mount

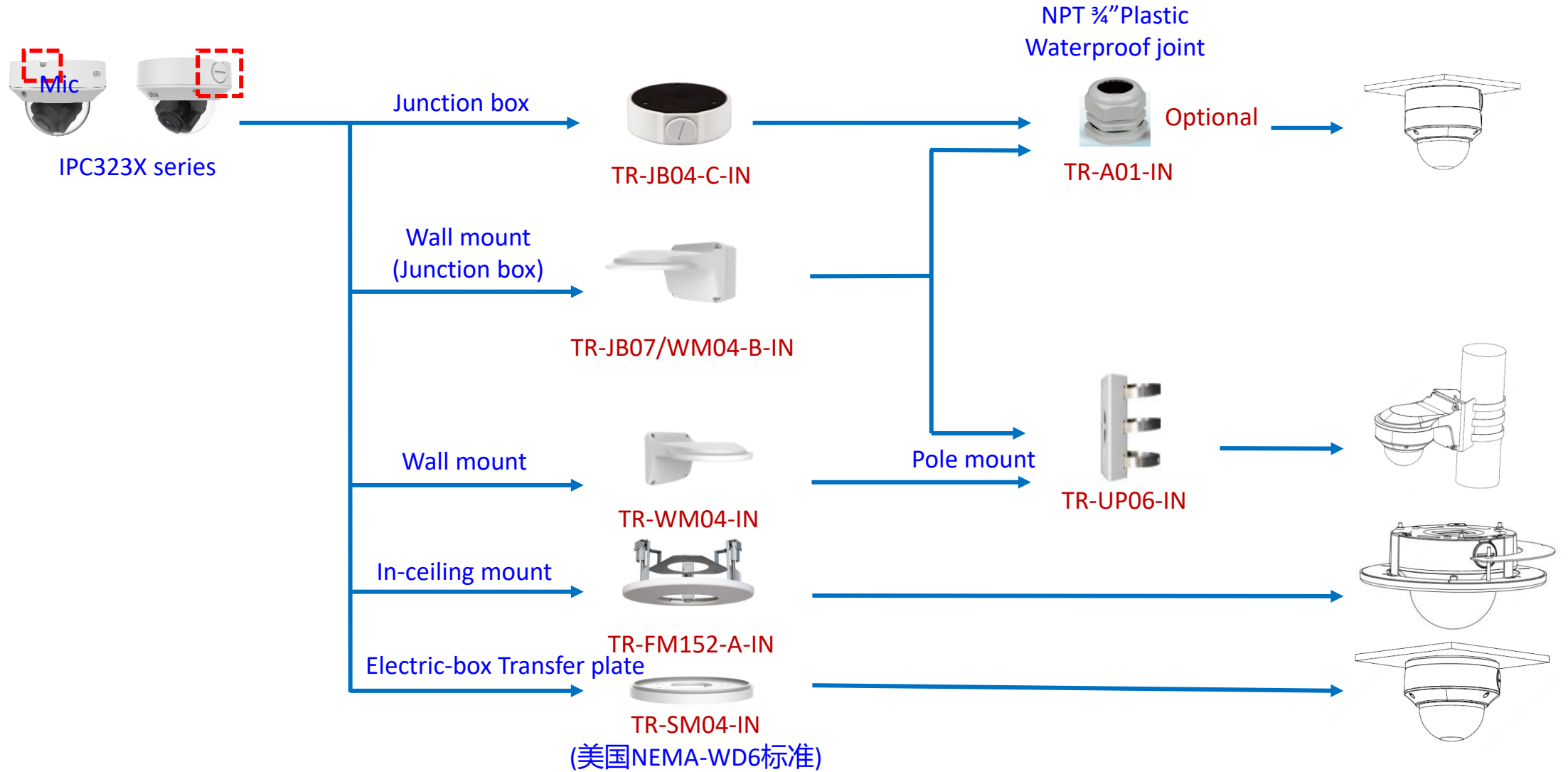

Dome camera mount

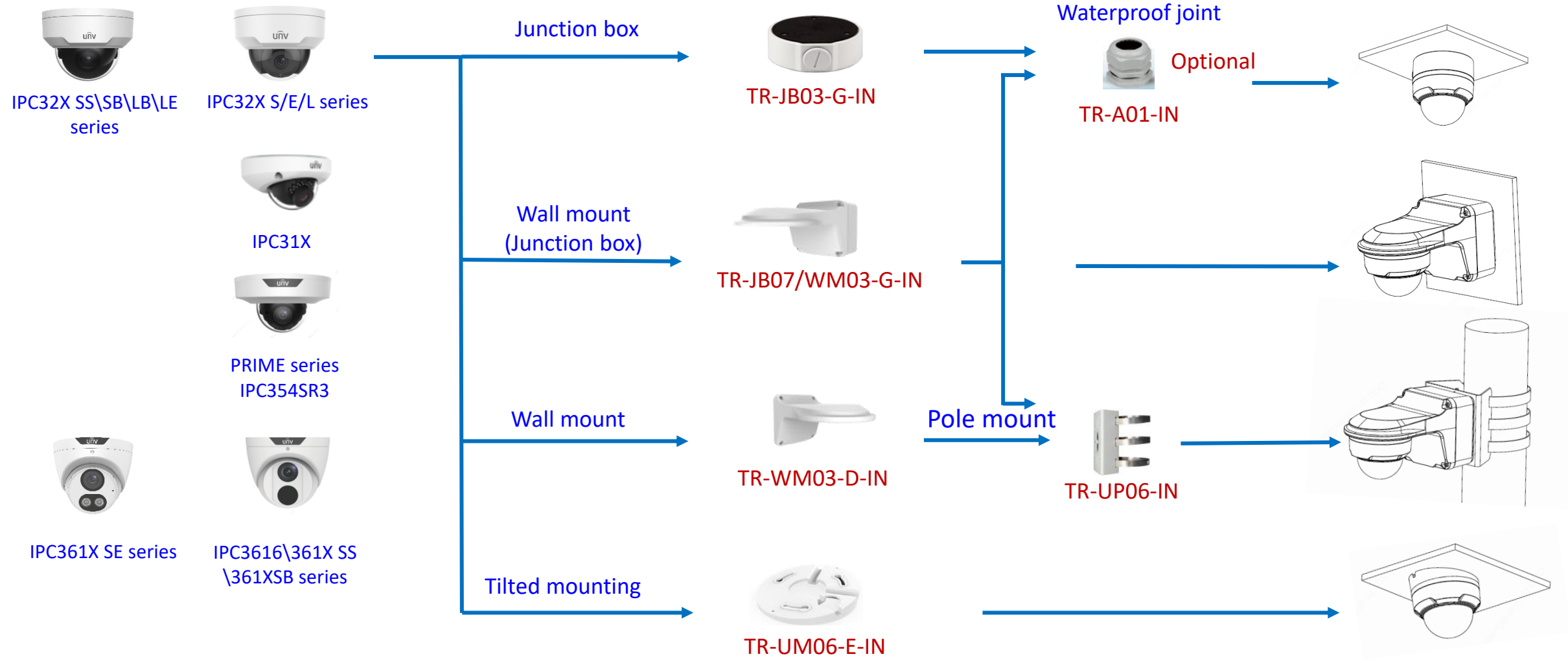

Dome camera mount

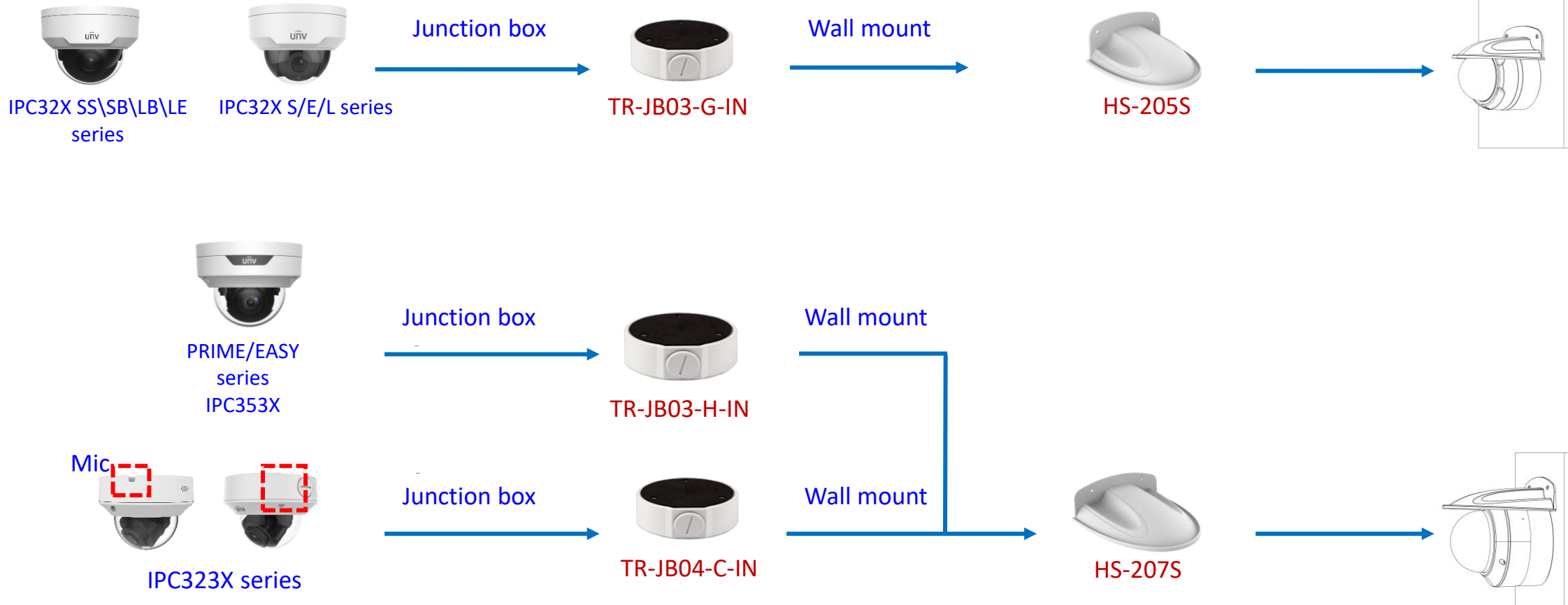

Electric-box Transfer plate

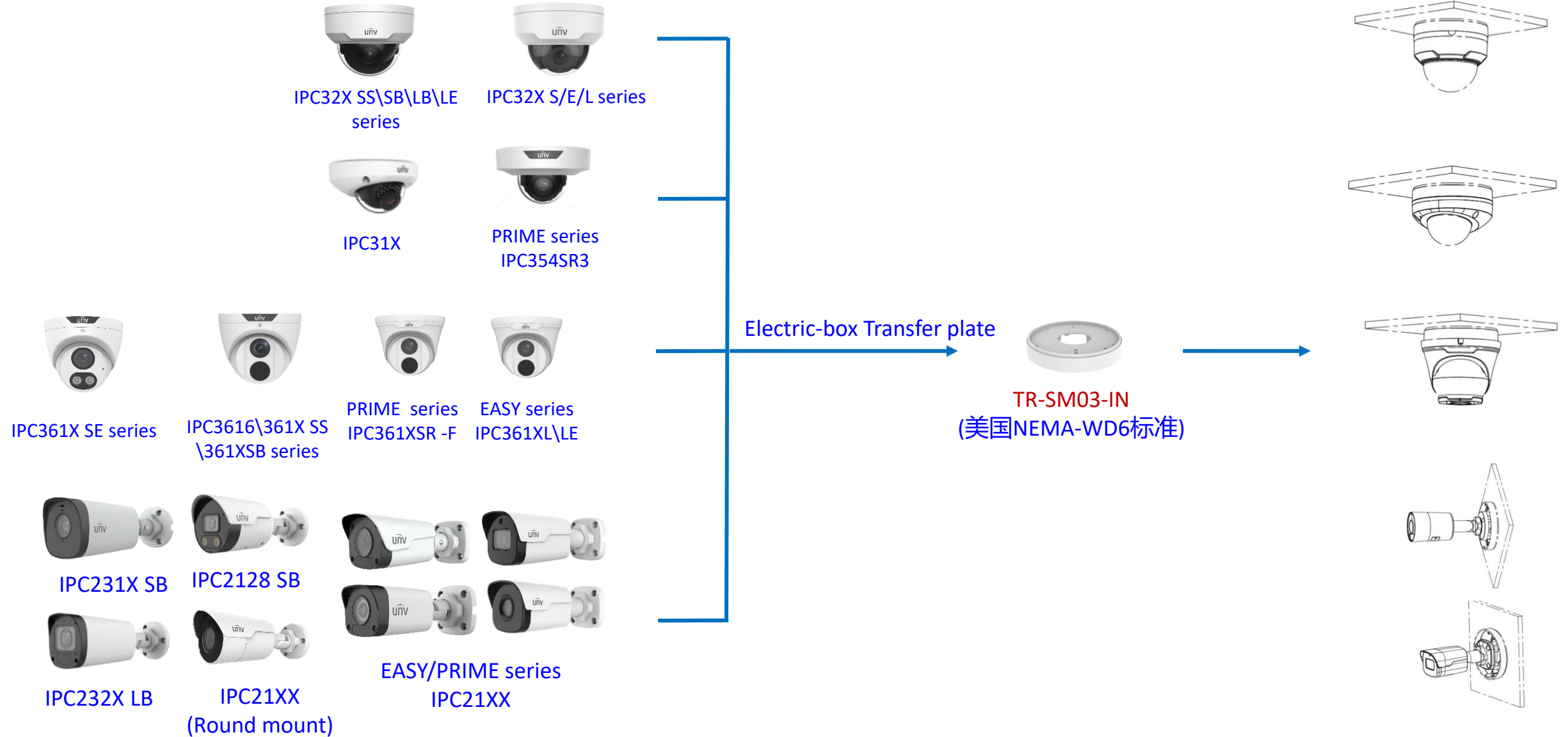

Dome camera mount

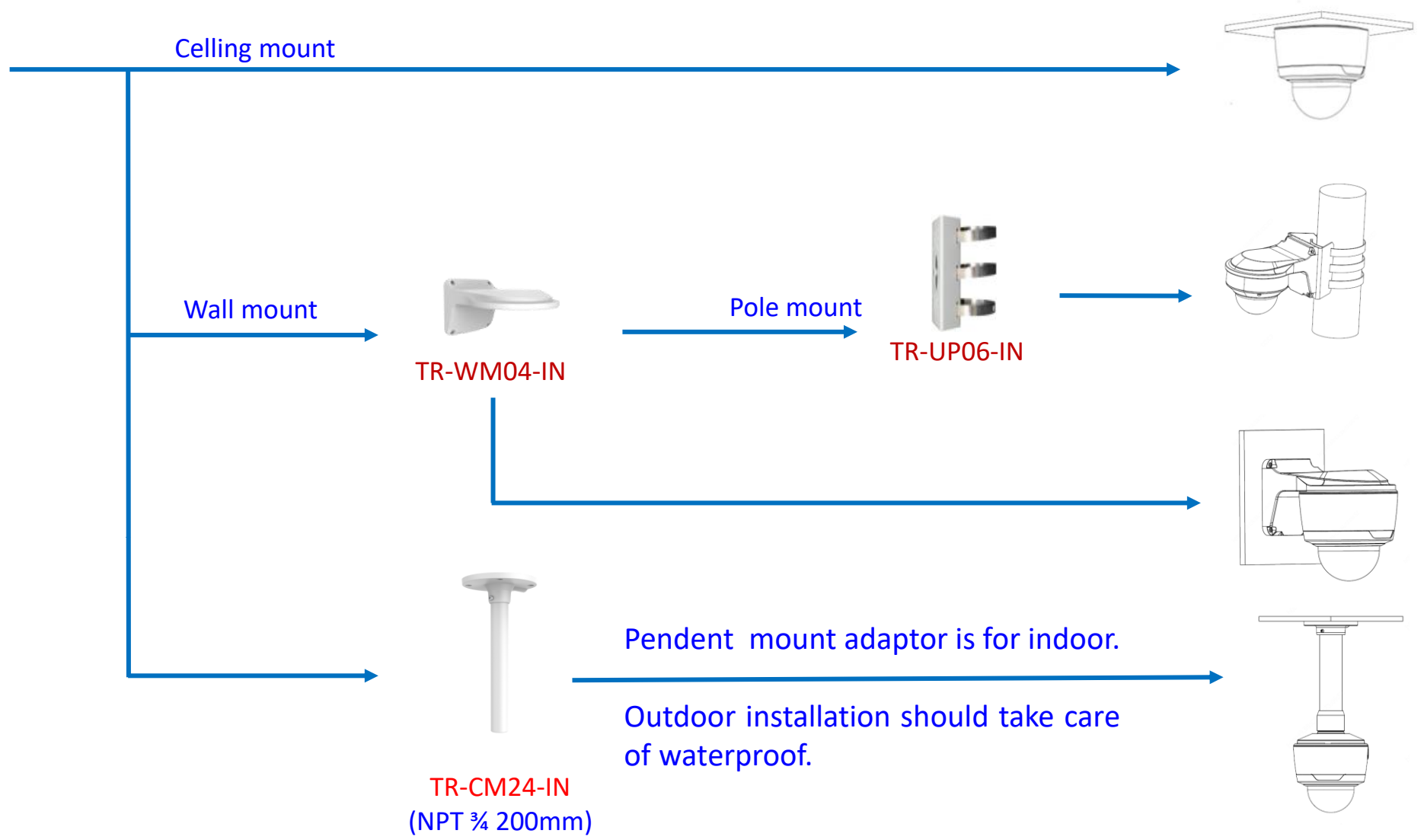

Dome camera mount

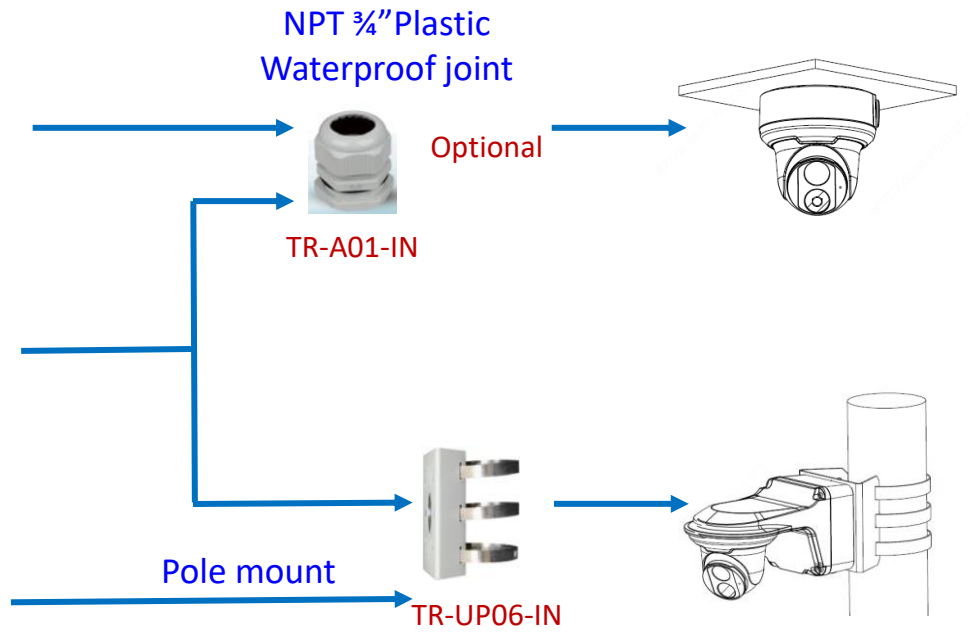
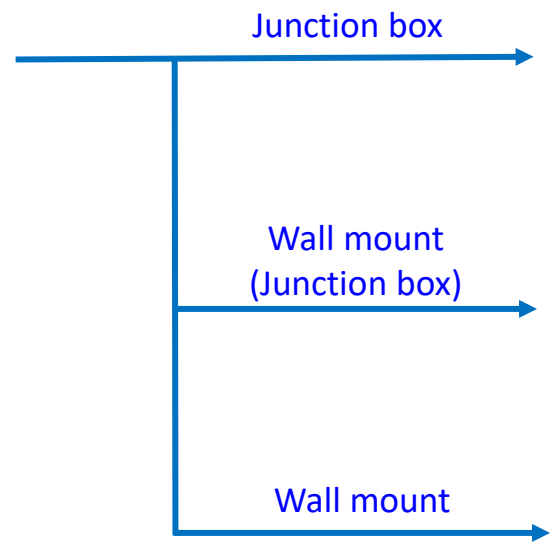
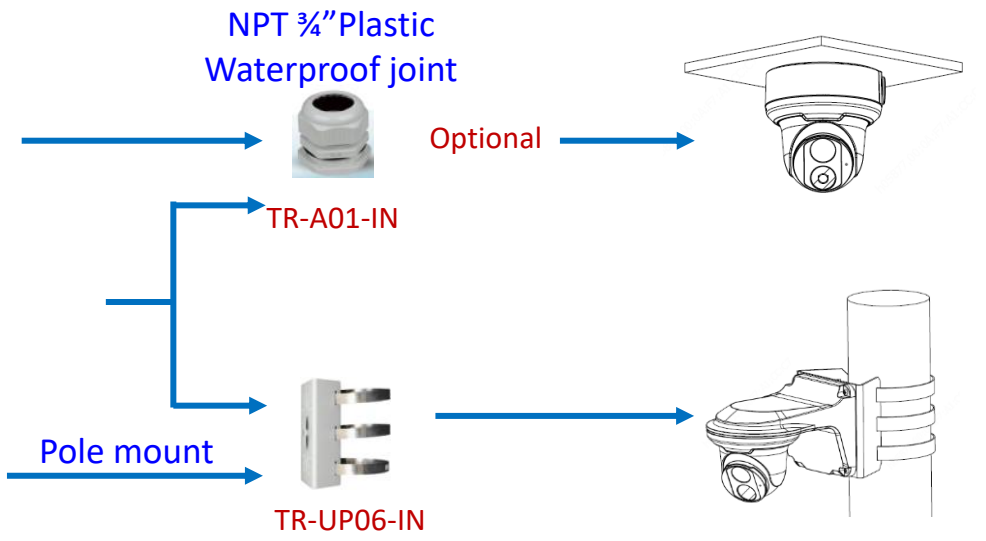
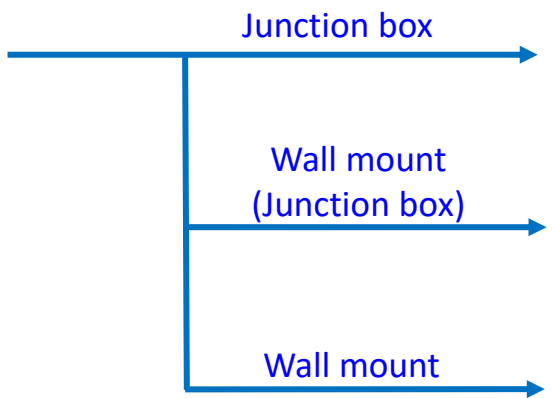

Fisheye camera mount

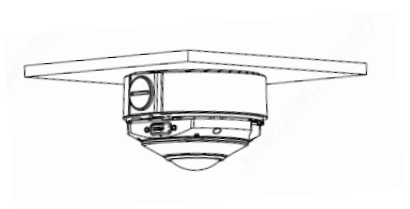

Dome camera Indoor pendent mount

*Release: 2019Q1



Junction box

- IPC323X series + TR-JB04-C-IN
- PRIME series
IPC363X
PRIME series
IPC361X S/E + TR-JB03-H-IN
Mini PTZ
PRIME series
IPC353X
- IPC361X LB/LE + TR-JB03-I-IN
IPC361X SR -F
- IPC32X series
IPC31X series + TR-JB03-G-IN
IPC354 series
IPC3616 series
IPC361X SS/SB series
- 868 fisheye + TR-JB04-D-IN
- 814 fisheye + TR-JB03-H-IN
815 fisheye
-  IPC373XSE series

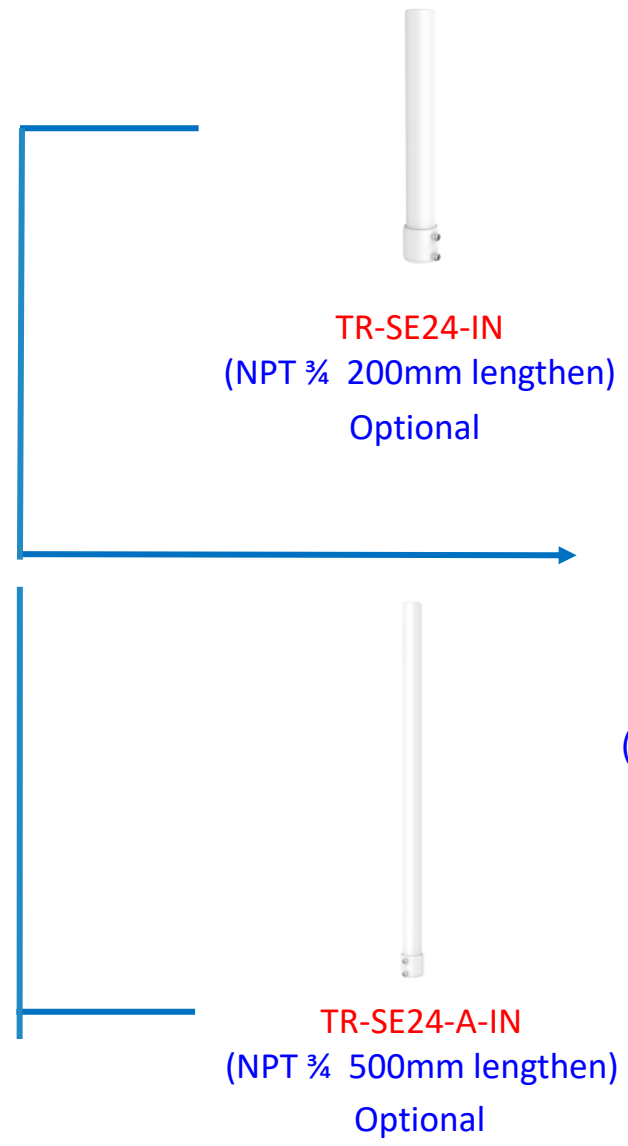

TR-CM24-IN
(NPT 3/4 200mm)

Pendent mount adaptor is for indoor.

Outdoor installation should take care of waterproof.

Indoor pendent mount

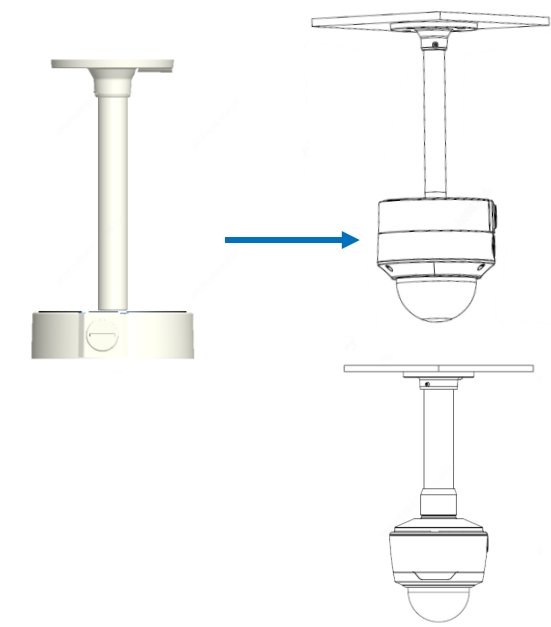

Bullet camera mount

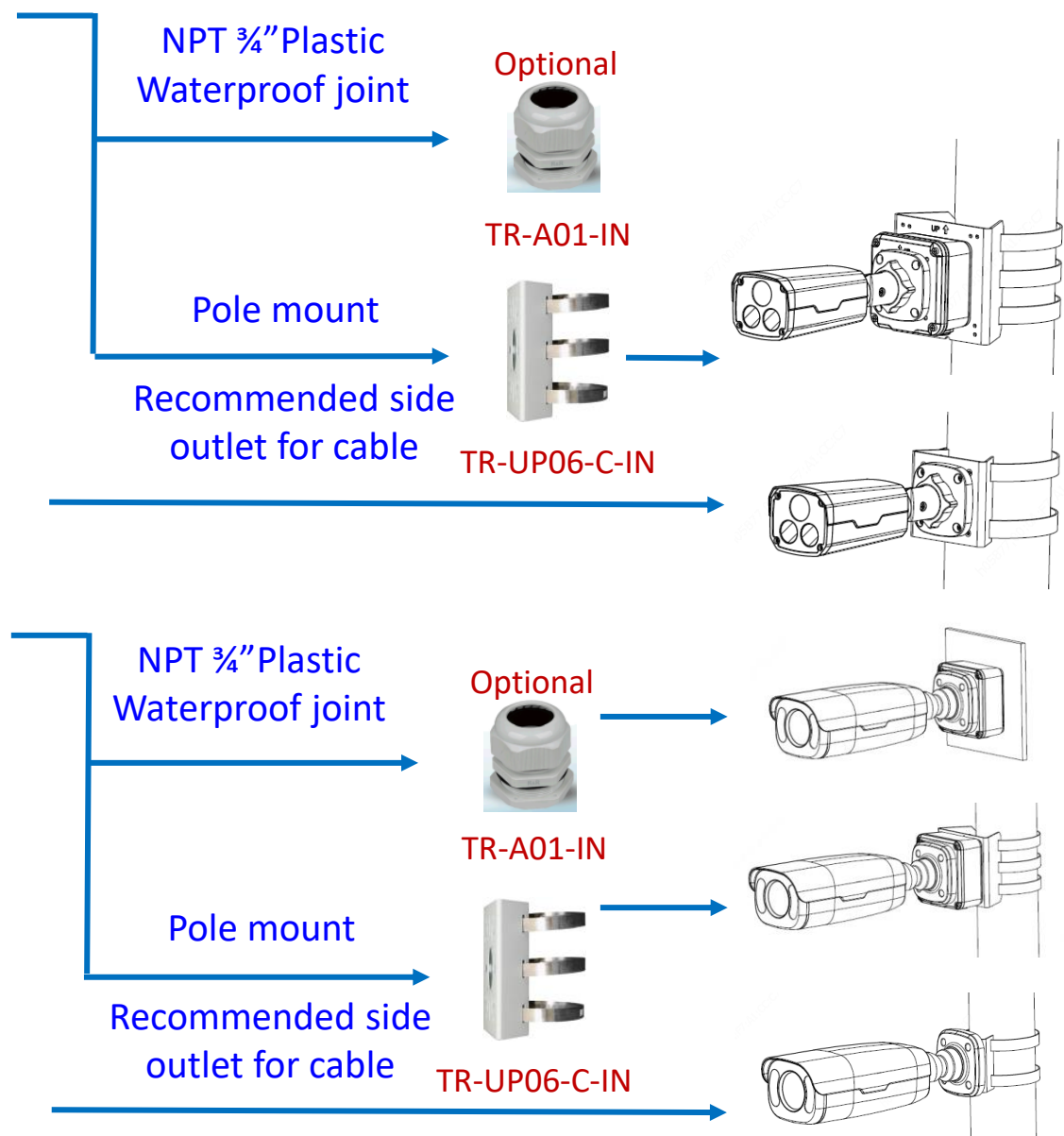
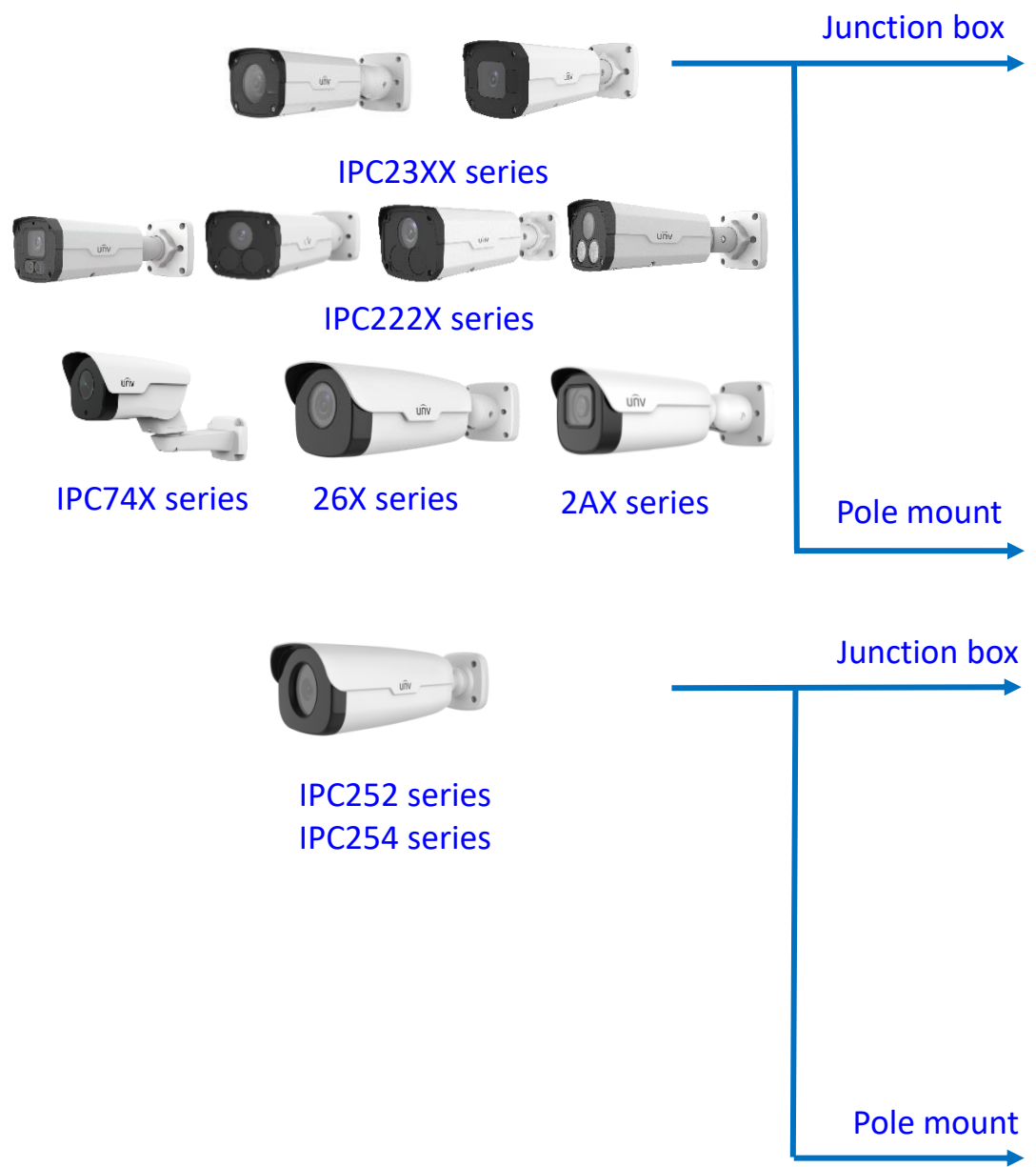

Bullet camera mount



IPC2C2X



IPC2A2X

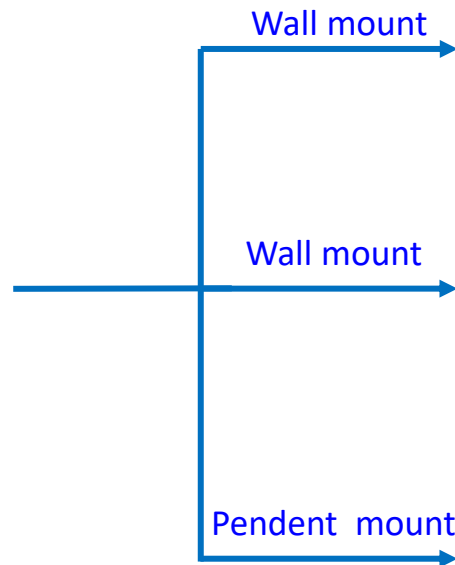

TR-WM06-F



TR-WM06-C-IN



TR-UM06-A-IN

Pole mount



TR-UP06-B-IN

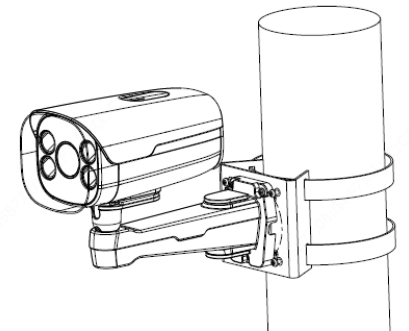

Mini Bullet camera mount



EASY/PRIME series
IPC21XX



IPC231X SB IPC2128 SB



IPC232X LB IPC21XX
(Round mount)

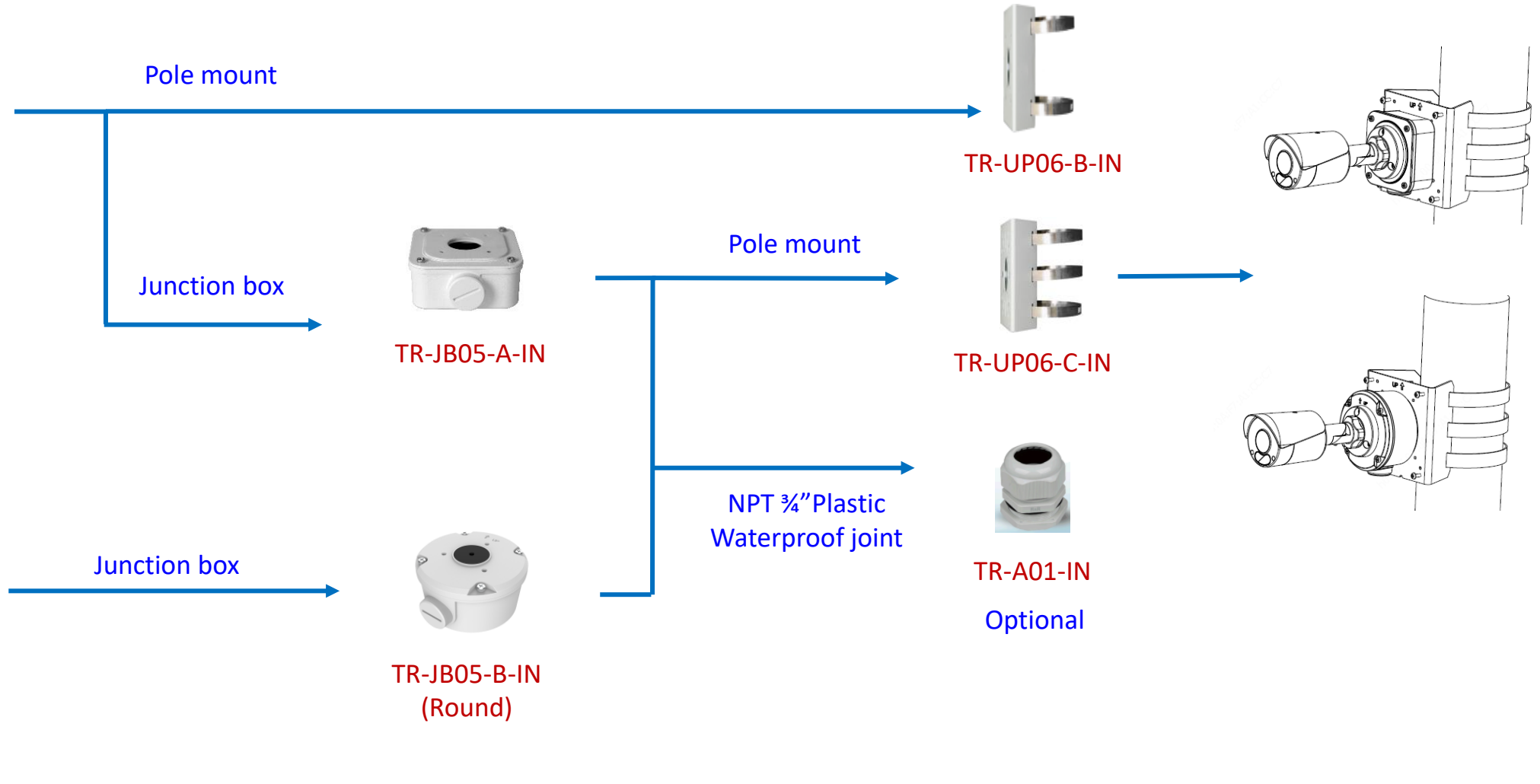

Bullet camera mount

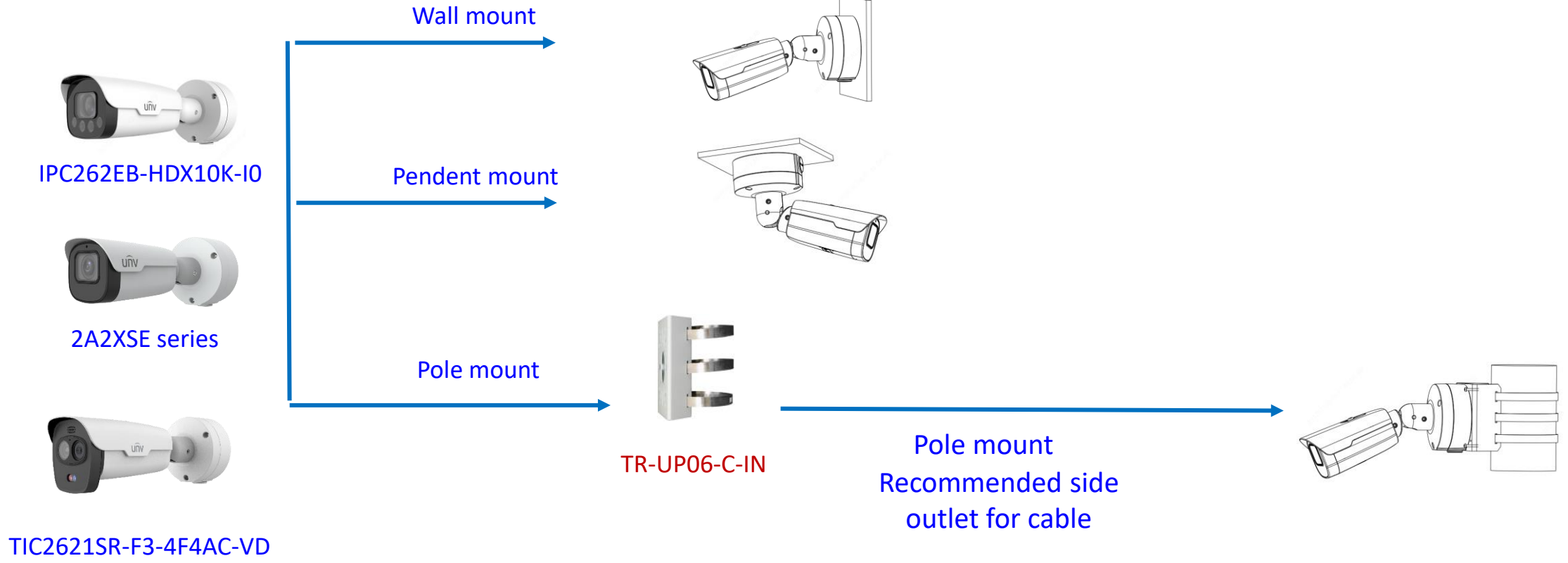

Positioning system mount



IPC672 Series



IPC6312 Series



IPC675 Series

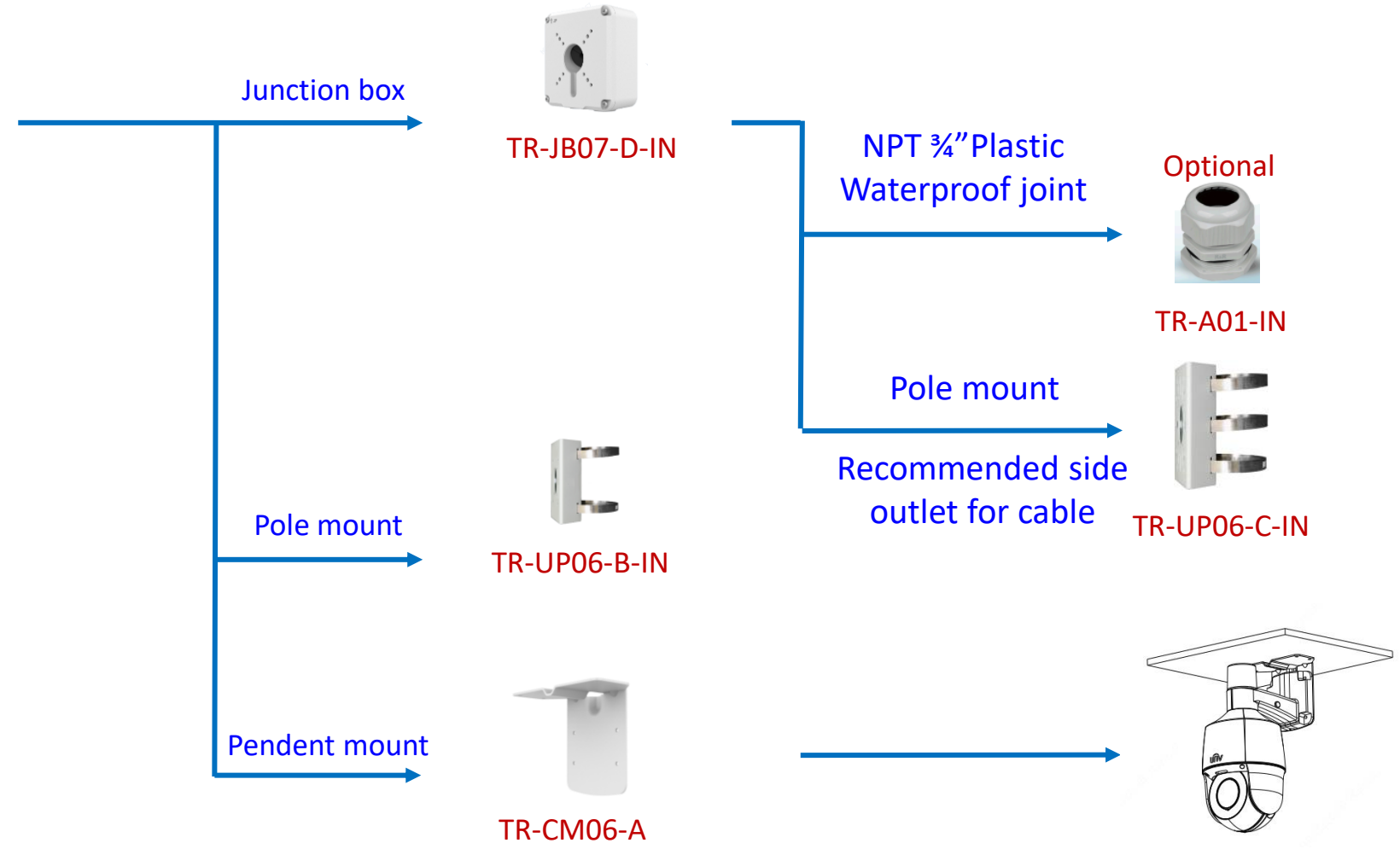

PTZ camera mount



IPC62xx Series
IPC63xx Series
IPC66xx Series



IPC6424SR-X25-VF

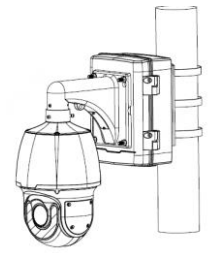
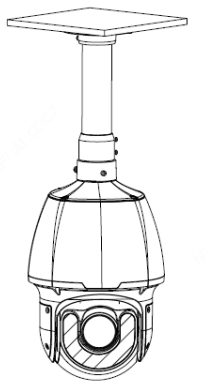
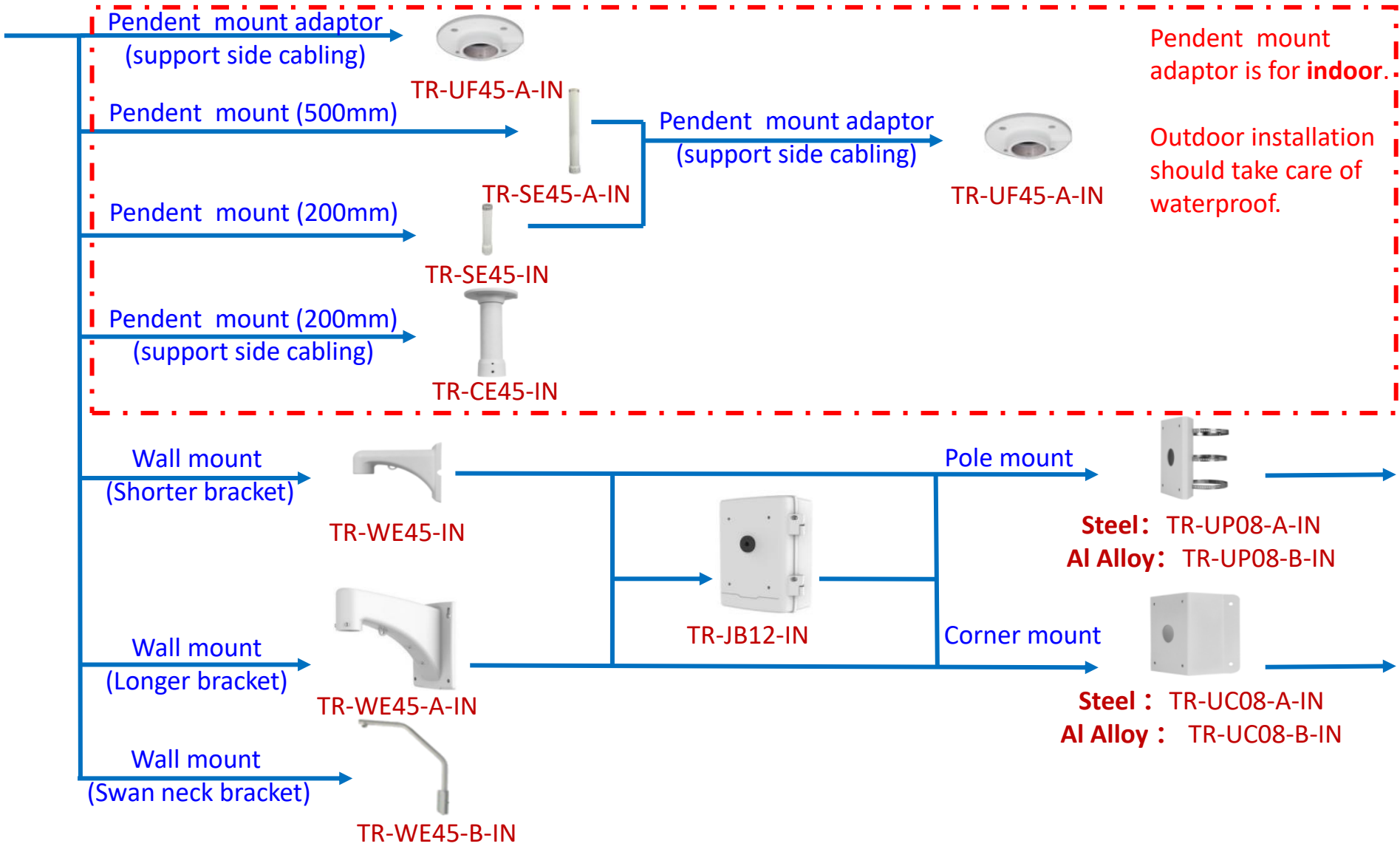

PTZ camera mount

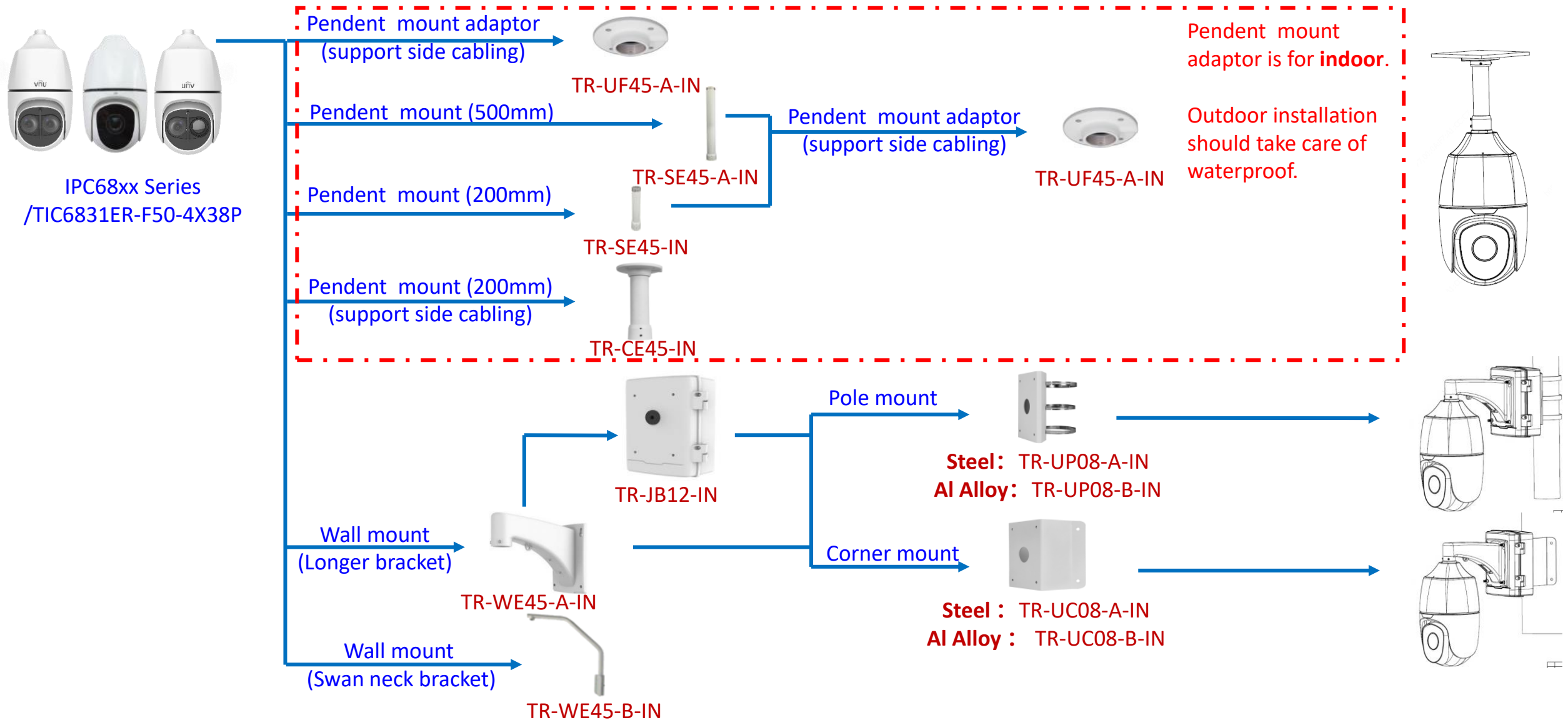

Indoor PTZ camera mount

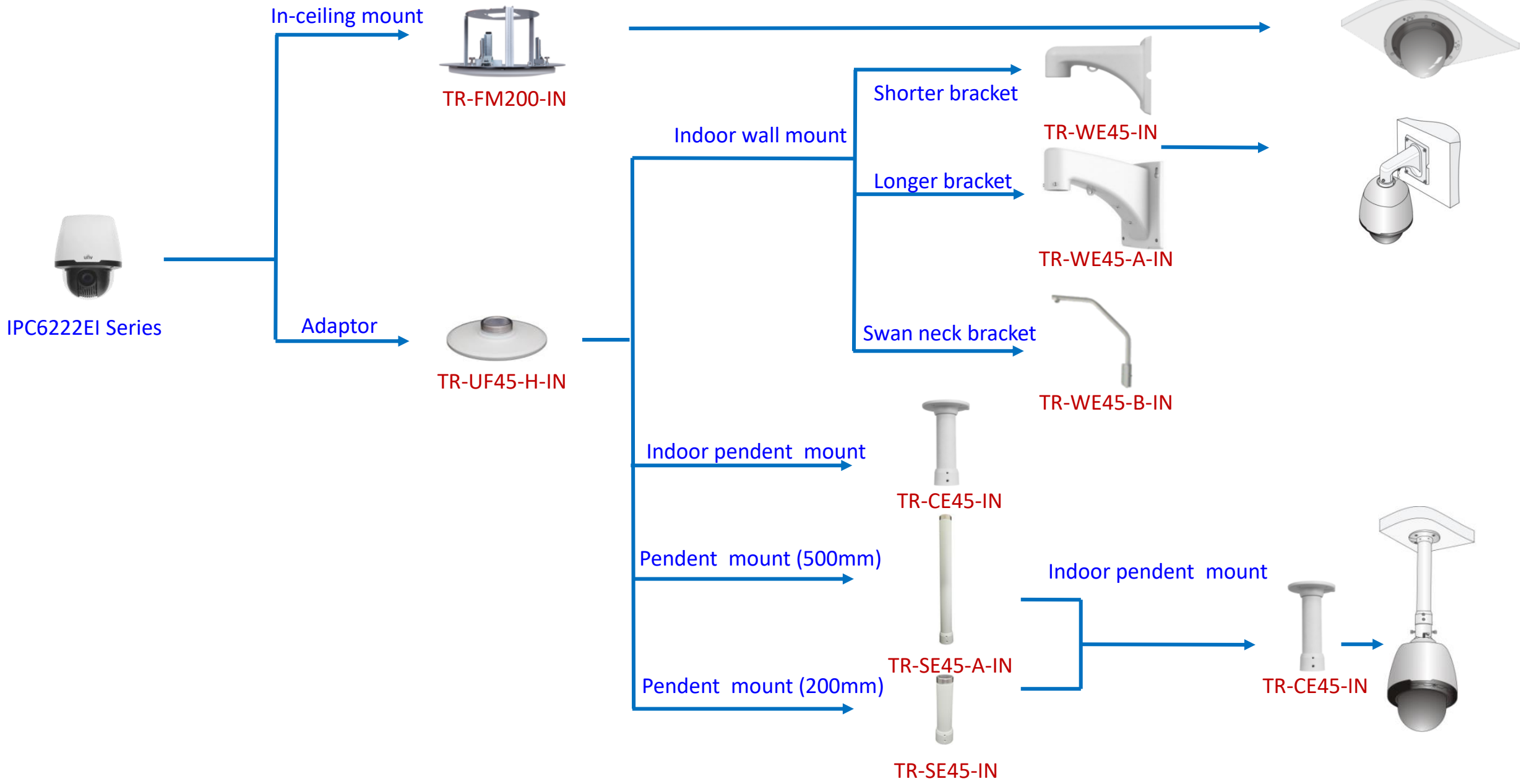

Indoor PTZ camera mount

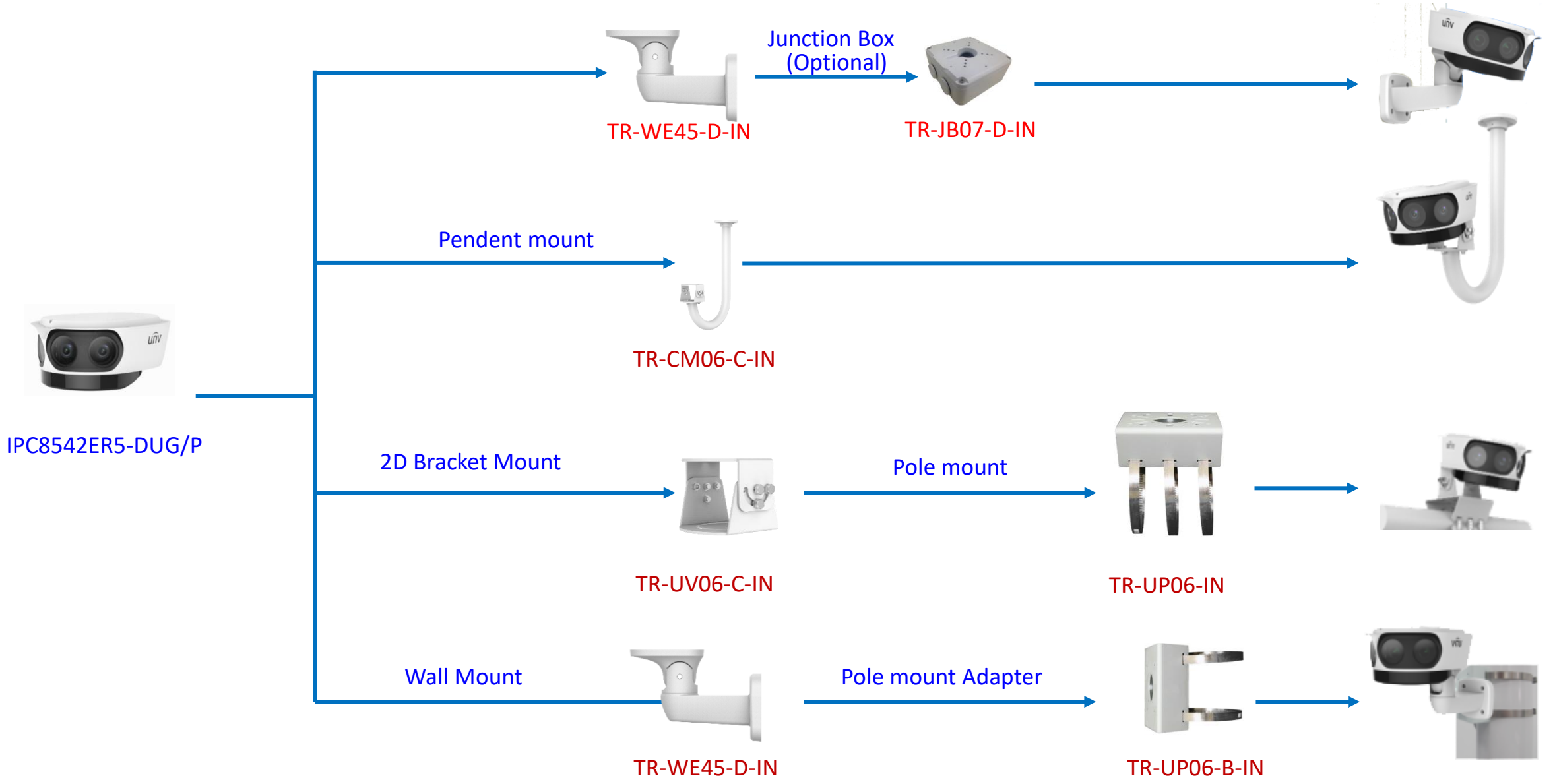

Omniview Network Camera + PTZ dome

Omniview Network Camera
+
PTZ dome



wall mount



TR-WE45-E-IN



pole mount



KIT-TR4-1



Positioning system mount

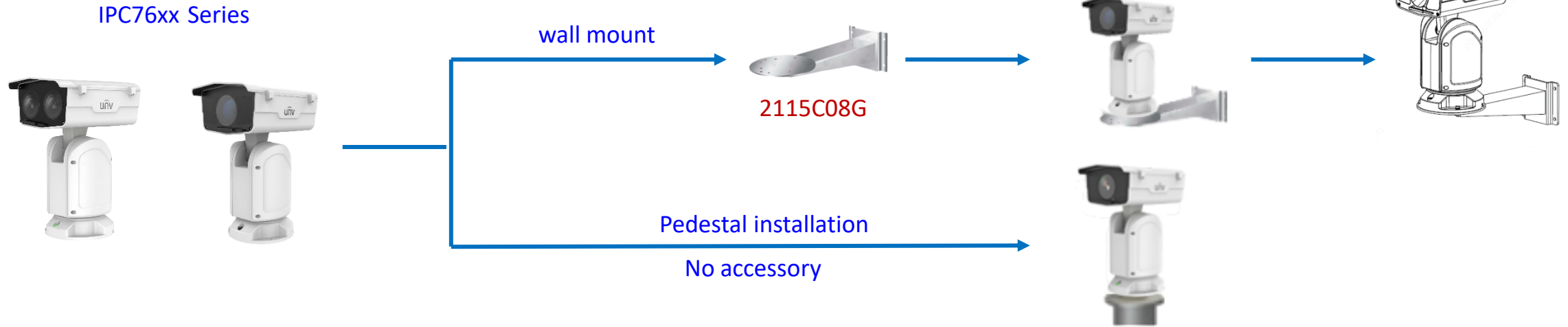

It is necessary to ensure that the mounting base is firm enough

The logo for Uniview, featuring the word "uniview" in a white, lowercase, sans-serif font. A thin white line arches over the "i" and "v". The text is centered within a white graphic element that consists of a horizontal line with rounded ends, forming a shallow U-shape that frames the text from below and sides.

uniview